

PS2-100 AHRP-23S

Solar Submersible Pump System kit for 3,5" wells

System Overview

Head	max. 18 m
Flow rate	max. 2,8 m³/h

Technical Data

Controller PS2-100

- Controlling and monitoring
- Control inputs for dry running protection, remote control etc.
- Protected against reverse polarity, overload and overtemperature
- Integrated MPPT (Maximum Power Point Tracking)
- Incl. MC4 to XT-60 adaptor cable / 0,5m of 4mm² PV cable

Power	max. 0,15 kW
Input voltage	max. 50 V
Optimum Vmp**	> 34 V
Motor current	max. 6,0 A
Efficiency	max. 98 %
Ambient temp.	-40...50 °C
Enclosure class	IP68

Motor ECDRIVE 100-AHR-S

- Incl. 15m of 3x 2, 5 mm² plugged motor cable
- Maintenance-free brushless DC motor
- Premium materials, stainless steel: AISI 304
- No electronics in the motor

Rated power	0,15 kW
Efficiency	max. 83 %
Motor speed	700...2500 rpm
Insulation class	F
Enclosure class	IP68
Submersion	max. 50 m

Pump End PE AHRP-23S***

- Premium materials: PPS
 - Helical rotor pump
- | | |
|------------|-----------|
| Efficiency | max. 57 % |
|------------|-----------|



Pump Unit PU100 AHRP-23S (Motor, Pump End)

Borehole diameter	min. 3,5 in
Water temperature	max. 50 °C

Standards



2006/42/EC, 2004/108/EC, 2006/95/EC

IEC/EN 61702:1995, IEC/EN 62253 Ed.1

The logos shown reflect the approvals that have been granted for this product family. Products are ordered and supplied with the approvals specific to the market requirements.

**Vmp: MPP-voltage under Standard Test Conditions (STC): 1000 W/m² solar irradiance, 25 °C cell temperature

***Specify temperature range on order



PS2-100 AHRP-23S

Solar Submersible Pump System kit for 3,5" wells

Pump Chart

Vmp* > 34 V

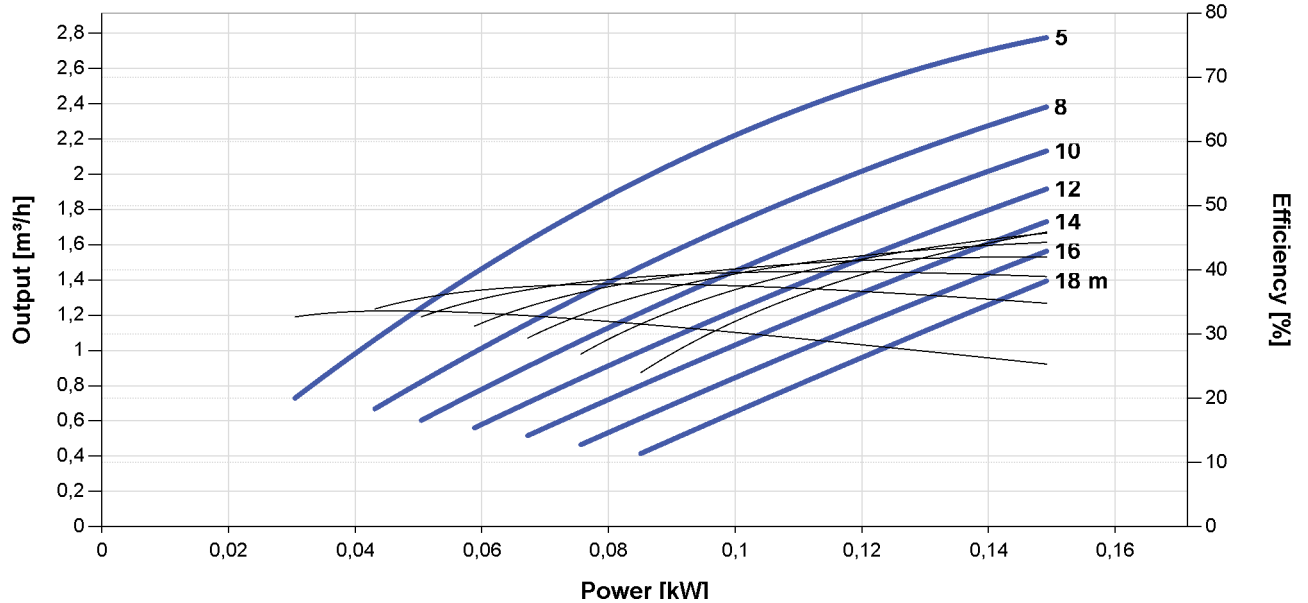

Dimensions and Weights

Controller

- H = 115 mm
- H1 = 101 mm
- H2 = 11 mm
- W1 = 122 mm
- W2 = 100 mm
- W3 = 80 mm
- D1 = 29 mm
- D2 = 20 mm

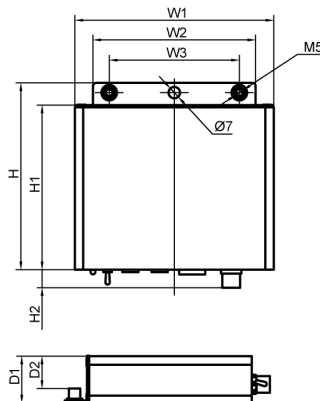

Pump Unit

- A = 455 mm
- B = 165 mm
- C = 290 mm
- D = 88 mm
- S = 1 in

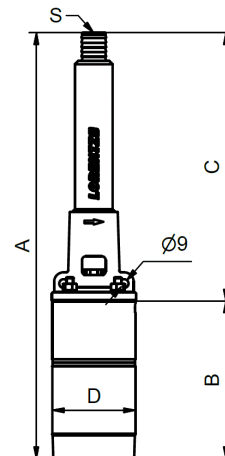

	Net weight
Controller	0,70 kg
Pump Unit	5,4 kg
Motor	4,5 kg
Pump End	0,90 kg

*Vmp: MPP-voltage under Standard Test Conditions (STC): 1000 W/m² solar irradiance, 25 °C cell temperature

